

# FaceDeep 3 & FaceDeep 3 **IRT**

Smart Face Recognition System  
Quick Guide V1.0

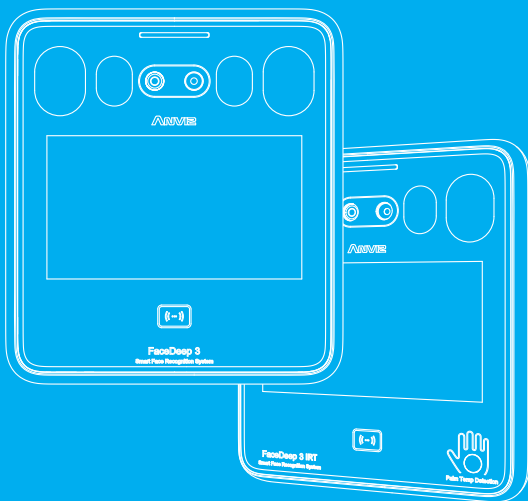

## ! Notice

- Do not use oily water or sharp objects to stain or damage the display screen.
- Fragile parts are used in the equipment, so please avoid operations such as falling, crashing, bending or heavily pressing.
- The normal working environment of the display screen and key parts of this equipment is indoor environment. Beyond this temperature range, the equipment will be less effective with reduced functionality and performance. Operating temperature:  $-10^{\circ}\text{C}\sim 50^{\circ}\text{C}$  ( $14^{\circ}\text{F}\sim 122^{\circ}\text{F}$ ), Operating humidity: 20-90%.
- Please gently wipe the screen and panel with material of soft cloth. Avoid scrubbing with water or detergent.
- The Face Deep terminal recommended power is DC 12V ~ 2A; When arrange the wires, if the 12V power supply cable is in long distance, resulting in large resistance, then the insufficient voltage ( $\leq 11\text{V}$ ), The device will be repeat restart, system crash and so on.
- When the ambient light change to dark, the Face Deep 3 has filling light itself.

## Parts List



Terminal



Mounting Bracket



Quick Guide

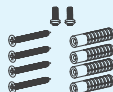

Accessories

## Appearance Description

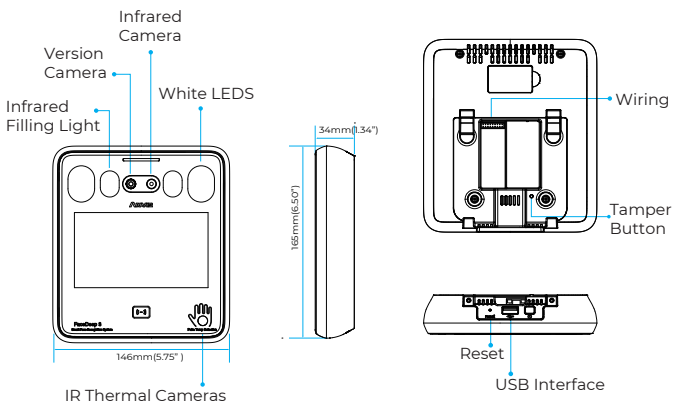

## Installation

The Sunlight and Hard Light may lead to big differences between site image and registered image; backlight, side-light and strong light will influence the recognition experience. (Analysis: from the view of human eyes, the color changes on face skin may result in wrong recognition of identity; unclear exposure area, no matter large or small, may influence the identity judgement.)



Side Light



Strong Light



Back Light

Device shall be installed in places avoiding backlight, side-light and strong light.

 The recommended place for Installation ( Please keep 3m away from the window, or does not influenced by sunlight, can be considered for installation)

 Backlight, side-light or direct strong light, not suitable for installation.

 Other areas, install in suitable places according to actual light impact.

 Hard Light  Door  Wall

 Curtain  Glass Window or Class Wall

### Sunlight Shines Indoor

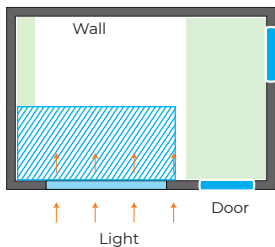

### Glass Window

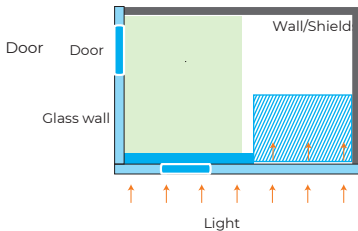

### Sunlight Shines Through the Door, with Glass Window at One Side

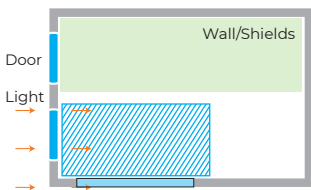

### Sunlight Shines Through the Door

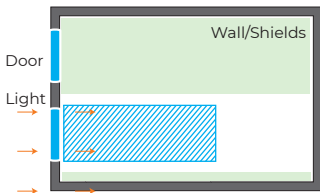

## Height

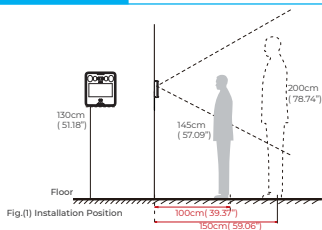

( Recommended Distance for Face Recognition )

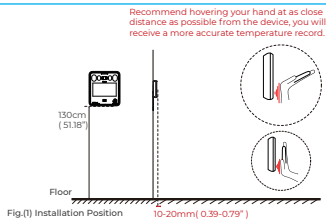

( Recommended Distance for Temperature )

Suggested installation height (the distance between the lens and the ground is 1.5m (59.06") , as the recognizable body height range, 1m distance away from the device, is 1.4-1.8m ( 55.12-70.87" ) ; the recognizable body height range, 1.5m ( 59.06" ) distance away from the device, is 1m-2.2m(39.37-86.61" ) . (There are some deviations) . The temperature detection range is 30mm(1.18").

## Steps

- 1 Keep the mounting bracket parallel with the ground and 1.2m distance to the ground. Drill 4 screw holes on the wall according to the mounting bracket ,

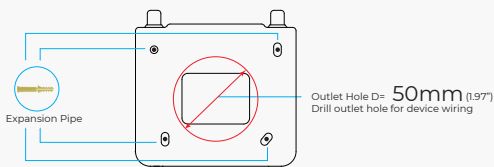

- 2 Please punch out the tail lines from the outlet hole before installing the mounting bracket and use the screws to fix the mounting bracket on the wall. Use the screwdriver to tighten the screw follow the direction indicated, to complete the installation.

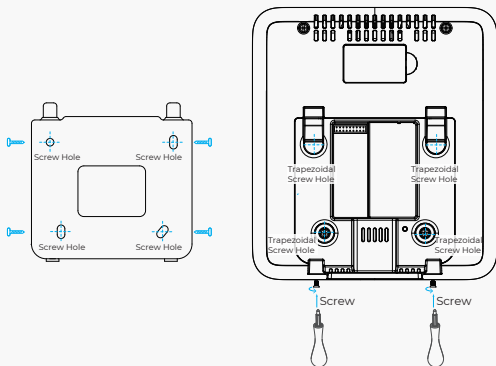

## Access Control Power Supply

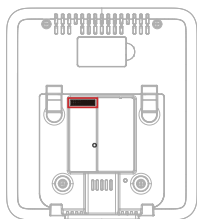

**FCARD MICROPOWER**  
 POWER SUPPLY CONTROLLER  
 MODEL: FC-901/903  
 INPUT: AC220/230W 50HZ  
 OUTPUT: DC12V, 3Amps+

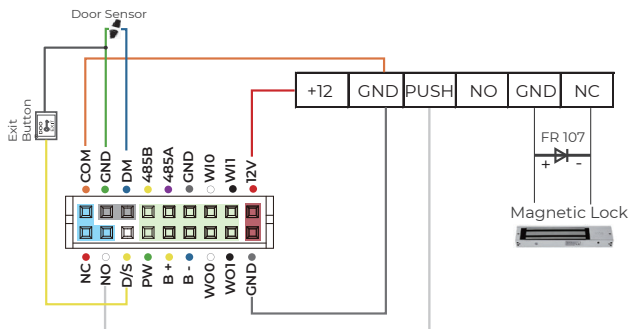

## Wiring Connection

SC011 and the FaceDeep 3 device are authorized by Anviz wiegand to form a distributed access control system. Please contact [sales@anziv.com](mailto:sales@anziv.com) for more information.

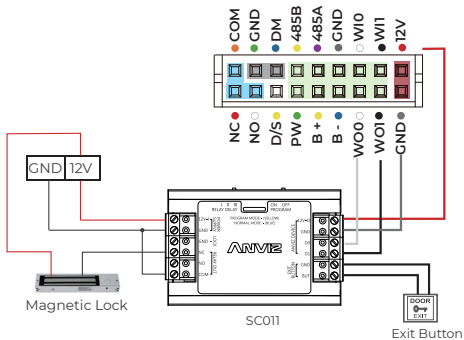

## Quick Guide

### General Settings



①

Power on the FaceDeep 3 and wait for the activation. Click [Face ID icon], then enter admin ID and password to access the main menu, or click [Verify icon] to verify the employee ID and password.

②

Click [Main Menu icon], then input default ID "0", password "12345" to enter main menu. You can change the admin password according to your needs, or set other users as administrators.

③

Enter system settings \ time to set date and time.

④

Check or edit device ID and admin password in system settings/device.

### Communication Settings

① Click "Network" option to enter network setting page, then select Ethernet or Wi-Fi

② Click "Network \ Comm Mode" to select server or client mode.

③ Set Ethernet or WiFi parameters based on your network environment.

④ PING v IP address on a management computer to make sure the device is connected.

#### Ethernet Setting

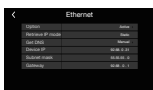

①

Click "Network" option to enter network setting page.

②

Click "Internet" to set WAN mode as Ethernet, and then set DNS IP address.

③

Click "Comm Mode" to select server or client mode.

④

Click "Ethernet" to modify TCP/IP settings.

#### Wi-Fi Setting

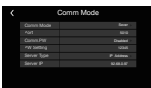

①

Click "Internet" to set WAN mode as Wi-Fi, and then set DNS IP address.

②

Click "Comm Mode" to select server or client mode.

③

Click "Wi-Fi" to modify the TCP/IP settings. Click "Choose Wi-Fi" to move to the next steps.

④

will automatically search all available Wi-Fi. Select one to finish the connection.

## User Enrollment

### Quick Face Registration

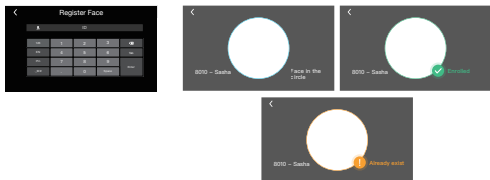

①

②



Click "Enroll Face" and input ID for quick face registration.

- Keep face in the center of the detection frame, according to the device request.
- Slightly move head left and right, up and down during the registration.
- If the registration process takes too long or fails, please change the registration position.
- In some cases, the detection frame might move to the top, it might be triggered by glasses. Take the glasses off, and try one again.

### Registration of Other Authentication Methods

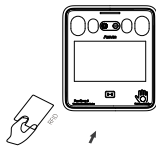

①

②

① Click "User"/"Add" to input ID, Password and Name. Click "Register Face" to enroll.

Click "Card" and swipe the card at the card detection area to finish the registration.



### TIPS

Do not cover the forehead and keep facial area that belows the eyebrows visible during the face registration. In order to improve comparison accuracy, users need to attempt multiple possible angles. Be careful not to change the facial expression (smiling face, drawn face, wink, etc.).

## To Switch the Status of "IN" or "OUT"

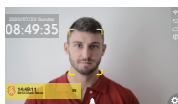

①

When the User pass the face verification, the status of "IN" will be available.



②

Click "IN" --> Choose Status --> Press "OUT" if need.



③

3. Meanwhile, if you want to see the logs of Time and attendance, please pick up "📄".

## To Import and Export the Lots of Face Photos of Users to be Enrolled with USB Disk

- To setup a new folder in the root directory of your usb stick, rename it ,eg. "Face"
- Select the Face photos to be imported and rename as the actual ID number, to save these photo files into the Folder of "Face ", eg. 1000001.jpg
- Add a new file of Users.xls in the "Face" folder, and fill in the personnel information you want to import as the follows.

User ID	Name	Card NO.	Group No.	Face Image File Name(End in .jpg)
1000001	James	123456789	1	1000001.jpg

- 4. Copy the Folder as well as the photos to USB Disk, and then insert the USB back to FaceDeep 3 Terminal.
- 5. Enter Menu--> Press "Data" -->" Import"--->"Data Import"--->"Face Import"--> Press" Import"

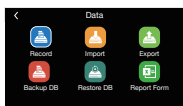
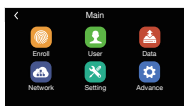

### \* The Face Photo of User should be :

File Format: JPG image

Size: the maximum size are 500KB.

Dimensions: 100 pixels < Width < 2000 pixels, 100 pixels < Height < 2000 pixels



## How to Setup Temperature

Press " Menu", Click " Advanced\Temperature", then you can reset or modify the setup accordingly if need.

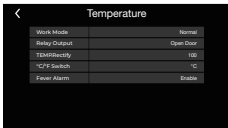

## Matching Precision Settings

- **Three precision levels** : Basic/Good/Excellent
- **Basic**: Excellent face comparison speed.
- **Good**: Fast face comparison speed with high secure protection, recommended.
- **Excellent**: Top security precision, recommended using in a high secure properties.

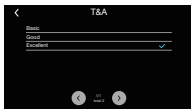
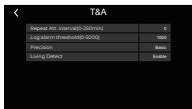

①

Enter from Main menu to  
Advanced(T&A)\Precision

②

Precision levels:  
Basic/Good/Excellent



In order to protect the environment, Anviz has decided to go "CD Free" campaign since June 1st 2019. We will provide QR code for you to download the electronic documents to make sure that you understand how to install and use Anviz devices.



<https://bit.ly/2WugbYp>

Dropbox



<https://bit.ly/2Vn0wh6>

Google



<https://bit.ly/2J9qA95>

Anviz

Anviz brand and product are trademarked and protected under law of the United States.  
Unauthorized use is prohibited.

For more information, please visit [www.anviz.com](http://www.anviz.com), or send email to [sales@anviz.com](mailto:sales@anviz.com) for more help.

©2021 Anviz Global Inc. All Rights Reserved.